

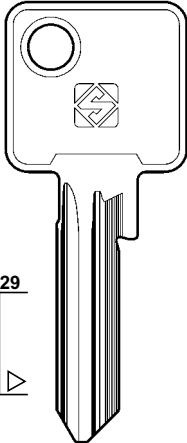









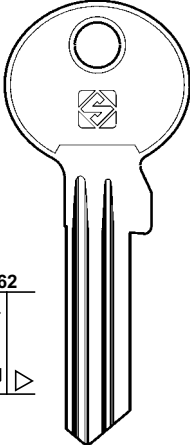

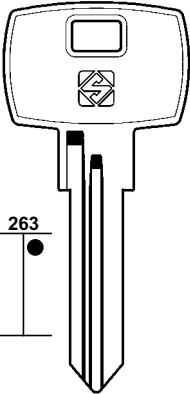

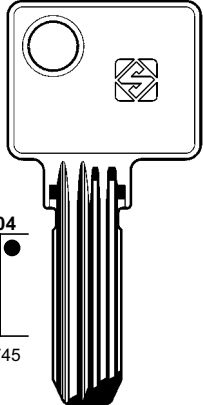

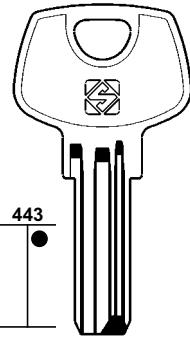

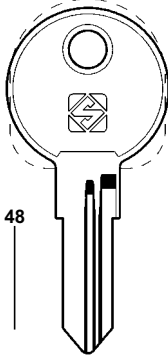
PER: ABUS	BAB			
 <p>1329 ▲ 5 ▽</p> <p> AB72 K1S</p> <p> AB72R K1D</p>		 <p>62 ▲ 5 ▽</p> <p> BAB31 N26</p>		<p>1</p>
<p>PER / FOR</p> <p>ABUS (D)</p> <p>BAB (D)</p> <p>BURG WÄCHTER (D)</p> <p>DOM (D)</p> <p>HÄFELE (D)</p>				
PER: FOR: BURG WÄCHTER	DOM	HÄFELE		<p>www.silca.de</p>
 <p>263 ●</p> <p> BUR32</p>  <p>804 ●</p> <p>S745</p> <p> BUR33</p> <p> mm 50-60</p>	 <p>443 ●</p> <p> DM138</p> <p></p>	 <p>48</p> <p> HF75</p>		

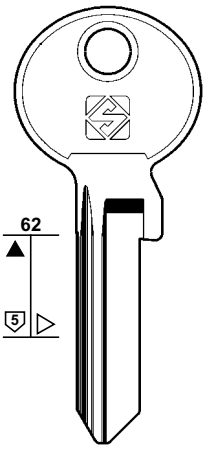
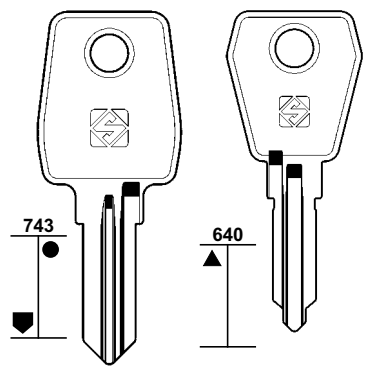
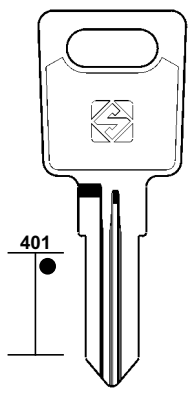
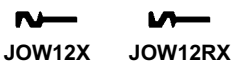
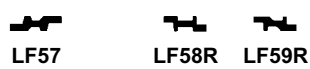
Copyright by Silca S.p.A. 2004

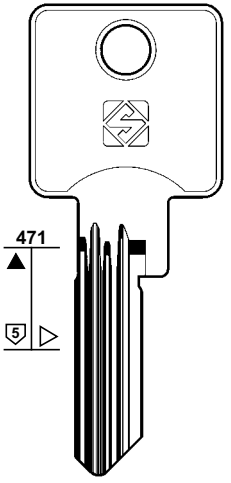
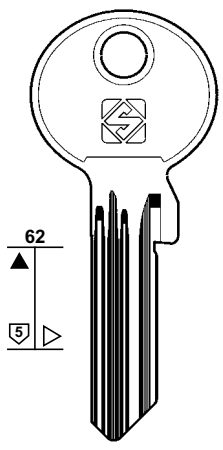
	<p>PER: JOWIL</p> <p>FOR:</p>	<p>PER: L & F</p> <p>FOR:</p>	<p>PER: RONIS</p> <p>FOR:</p>
	<p>2</p> <p>PER / FOR</p> <p>JOWIL (D)</p> <p>L & F (GB)</p> <p>RONIS (F)</p> <p>TOK-WINKHAUS (D)</p>	      	<p>PER: TOK-WINKHAUS</p> <p>FOR:</p>
	  	  	

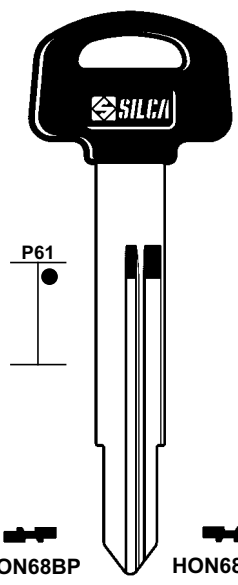
www.silca.de

Copyright by Silca S.p.A. 2004

Silca GmbH
 Siemensstr. 33
 D-42551 Velbert
 Telefon +49 2051 / 271-0
 Telefax +49 2051 / 271-172
 e-mail: verkauf@silca.de
 internet: www.silca.de

* Dieser Artikel ist nicht Bestandteil des weltweiten Lieferprogrammes der SILCA SpA - Italy. Diesen Artikel können Sie zur Zeit nur in Deutschland erhalten.

Für die vollständigen Informationen bitte auch das Gesamt-Update Oct./Nov. 2004 aus dem Internet unter www.silca.de downloaden.



A Member of the Kaba Group

KABA MAUER



3

PER / FOR
KABA MAUER (D)

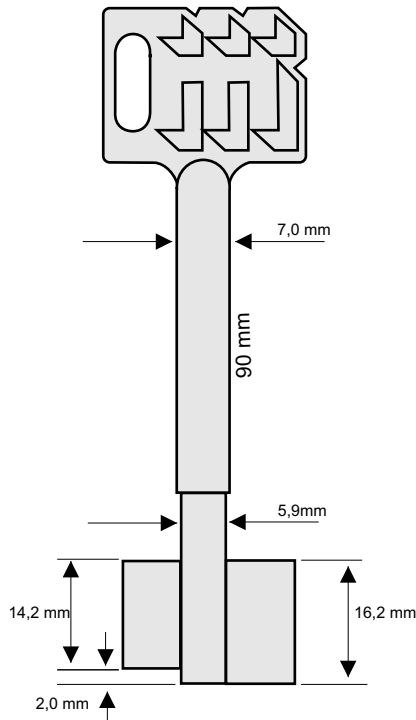

CFSM611 *

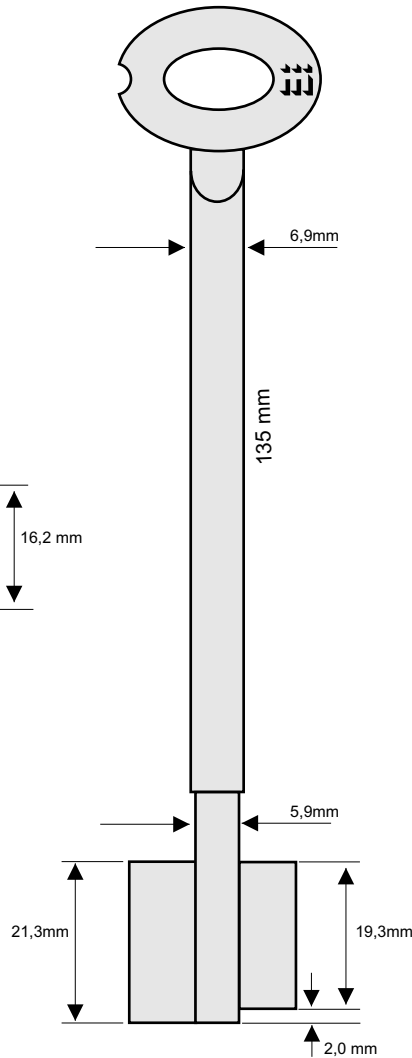

CFSM607 *

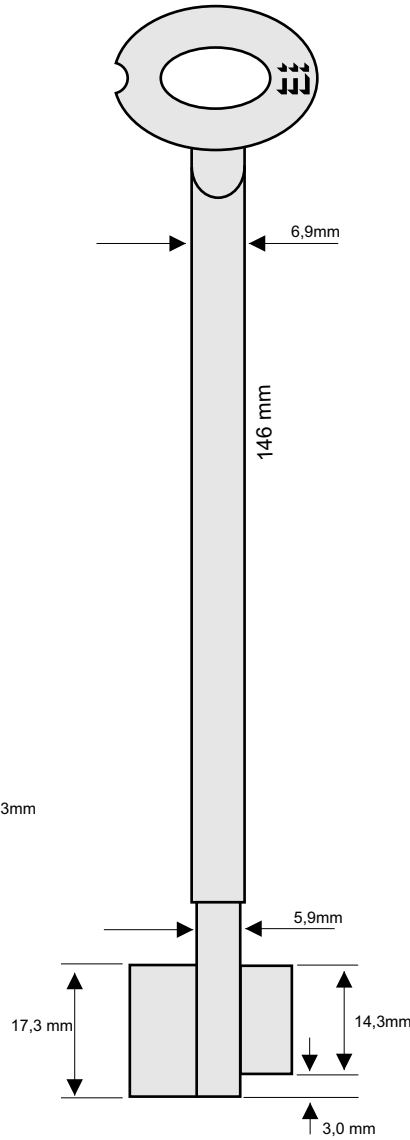







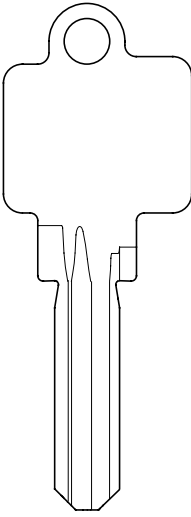
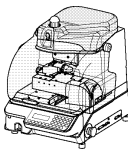
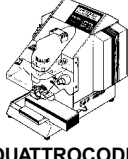

8990/M4 *
Messing

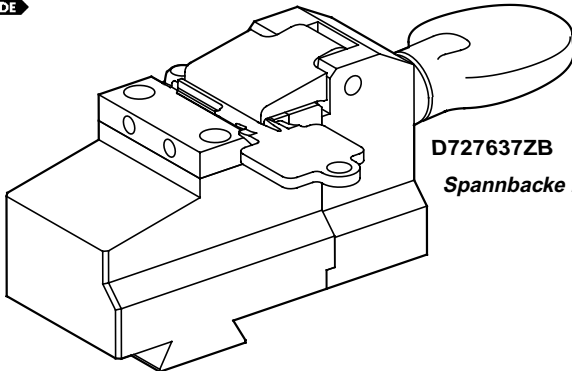
Copyright by Silca S.p.A. 2004

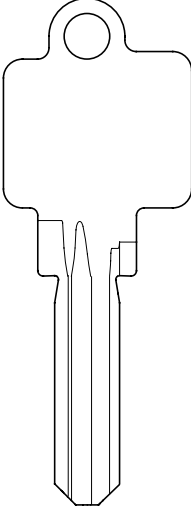
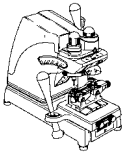
www.silca.de



	<p>PER: FOR:</p> <p>BKS (D)</p>  <p>WS50 Profil NW</p>	 <p>TRIAX-E.CODE</p>  <p>QUATTROCODE</p>	<p>OPTIONAL</p> <p> COPY</p> <p> CODE</p>  <p>D727637ZB Spannbacke R158</p>  <p>D726008ZB Fräser W273 (Hartmetall)</p> <p style="text-align: right;">NEW</p>
<p>4</p>	<p>BKS (D)</p>  <p>WS50 Profil NW</p>	 <p>MATRIX S - SX - SLX</p>	 <p>Art.Nr. DBKSW50AD *</p> <p>optional :</p> <div style="display: flex; justify-content: space-around;"> <div data-bbox="1141 1680 1189 1915">  <p>Taster T30 D401159RA</p> </div> <div data-bbox="1356 1680 1404 1915">  <p>Fräser F30 D701160ZB</p> </div> </div> <p style="text-align: right;">NEW</p>

www.silca.de

Copyright by Silca S.p.A. 2004

Silca GmbH
Siemensstr. 33
D-42551 Velbert
Telefon +49 2051 / 271-0
Telefax +49 2051 / 271-172
e-mail: verkauf@silca.de
internet: www.silca.de

* Dieser Artikel ist nicht Bestandteil des weltweiten Lieferprogrammes der SILCA SpA - Italy. Diesen Artikel können Sie zur Zeit nur in Deutschland erhalten.

Für die vollständigen Informationen bitte auch das Gesamt-Update Oct./Nov. 2004 aus dem Internet unter www.silca.de downloaden.



A Member of the Kaba Group



FORD (EU+USA)

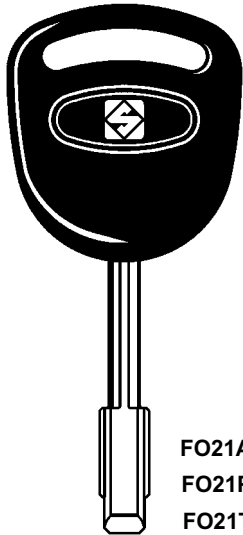

FO21AP
FO21PL
FO21T3
FO21T3L
FO21T17

FO21P FO21T3M



TRIAX-E.CODE

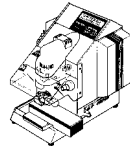

QUATTROCODE

OPTIONAL

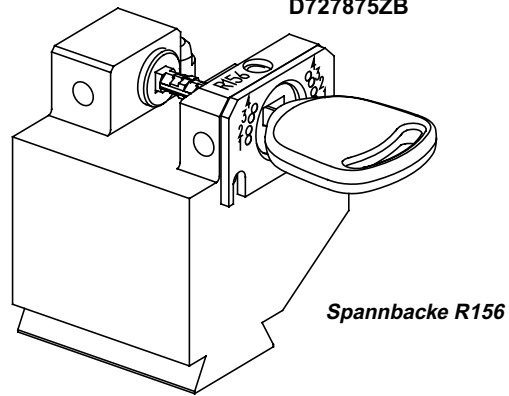

D727875ZB

Spannbacke R156

NEW

5

PER / FOR

STANDARD



D708742ZB
Fräser H101 (HSS)



D709238ZB
Fräser W101 (Hartmetall)

Kleine Bart/Doppelbartschlüssel

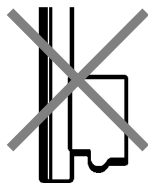
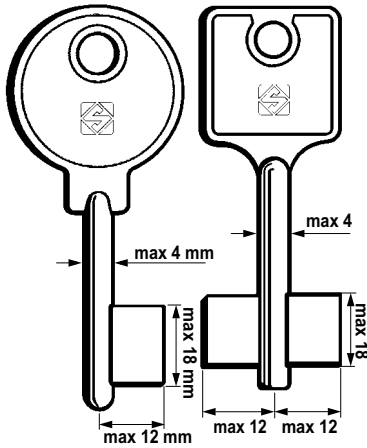

IDEA

OPTIONAL

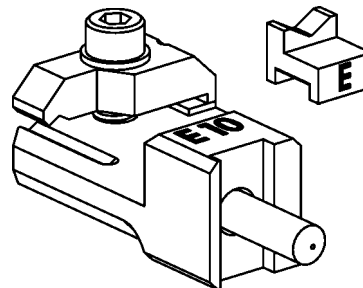

D727711ZB

Adapter für kleine Einbart-/Doppelbartschlüssel

Ab Idea Software Version 1.3.030 DB 3.00

NEW

www.silca.de

Copyright by Silca S.p.A. 2004





PER:
FOR:

NEW

6

WD-40

Inhalt :
24 Sprühdosen
a 100 ml



Art.Nr. AWD40 *

Wenn's quietscht, klemmt oder rostet... dann WD-40!

WD-40 bedeutet für Sie fünf Produkte in einem, denn **WD-40** wirkt gleichzeitig als

- Rostlöser
- Schmiermittel
- Kontaktspray
- Reiniger
- Korrosionsschutz

Werkzeuge werden gegen Korrosion geschützt, quietschende und knarrende Stellen wieder in Bewegung gebracht. Feuchtigkeit von Sicherungskästen und elektronischen Messgeräten wird gebannt. Kontakte werden sauber gehalten und hartnäckiger Schmutz wie z.B. Öl-, Fett- und Harzreste werden gelöst... und vieles mehr!

Ihr Vorteil mit WD-40: Die Leistung der Marke bedeutet, dass Sie auf teure Spezialprodukte verzichten können.

Bitte beachten Sie : das bisher von der Silca GmbH, Velbert vertriebene Produkt PROTEC wurde aus dem Programm genommen.

www.silca.de

Copyright by Silca S.p.A. 2004