

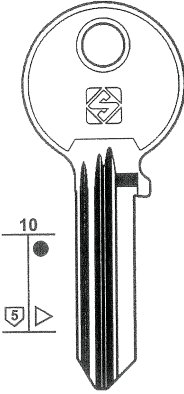







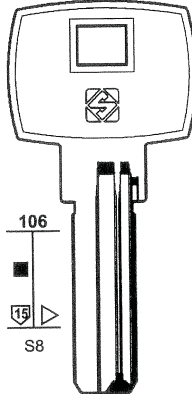

PER: FOR:	ABUS	DOM	FORT	 1						
	  AB75	  DM122 	  FRT6R							
	<table border="1"> <thead> <tr> <th>PER / FOR</th> </tr> </thead> <tbody> <tr> <td>ABUS (D)</td> </tr> <tr> <td>DOM (D)</td> </tr> <tr> <td>FORT (USA)</td> </tr> <tr> <td>KABA MAUER (D)</td> </tr> <tr> <td>RONIS (F)</td> </tr> <tr> <td>TOK (D)</td> </tr> </tbody> </table>			PER / FOR	ABUS (D)	DOM (D)	FORT (USA)	KABA MAUER (D)	RONIS (F)	TOK (D)
PER / FOR										
ABUS (D)										
DOM (D)										
FORT (USA)										
KABA MAUER (D)										
RONIS (F)										
TOK (D)										
PER: FOR:	RONIS	TOK-WINKHAUS	KABA MAUER							
	  RO69	  TO111R	 6MAU17 Material : Messing, Oberfläche vernickelt							

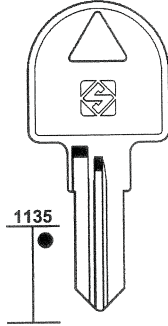
Copyright by Silca S.p.A. 2006

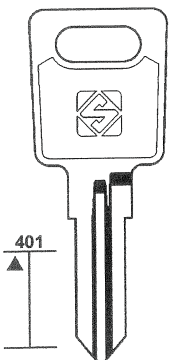
www.silca.de

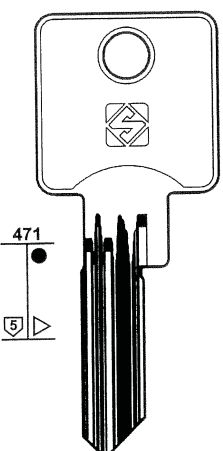
Silca GmbH
 Siemensstr. 33
 D-42551 Velbert
 Telefon +49 2051 / 271-0
 Telefax +49 2051 / 271-172
 e-mail: verkauf@silca.de
 internet: www.silca.de

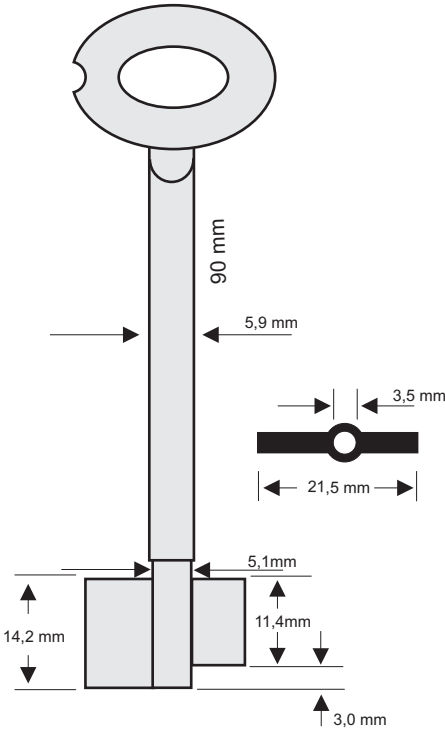
Irrtum und Druckfehler vorbehalten.

Für die vollständigen Informationen bitte auch die GesamtUpdates aus dem Internet unter www.silca.de downloaden.

Bitte beachten Sie, dass nur die oben genannten Artikel ab Lager Silca Deutschland kurzfristig verfügbar sind.



A Member of the Kaba Group



2

PER / FOR
HUF (D)

PER:
FOR:

HUF

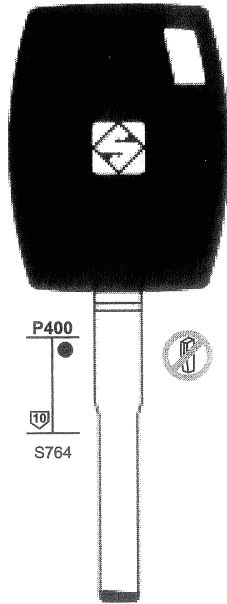

HU101T20

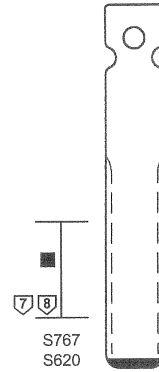

HU83T

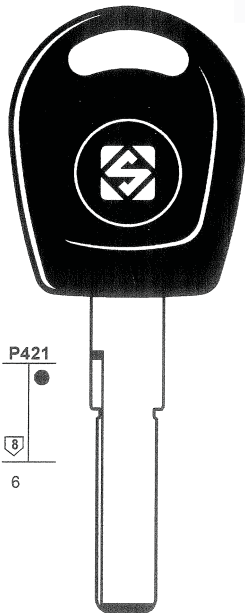

HU66P

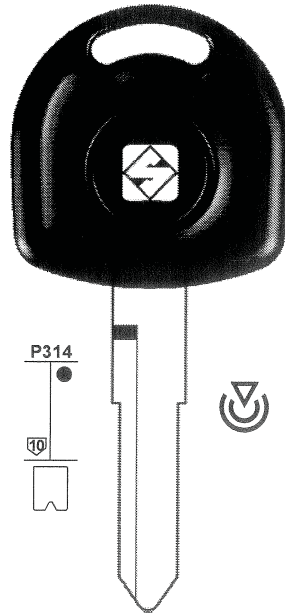

HU87RT5

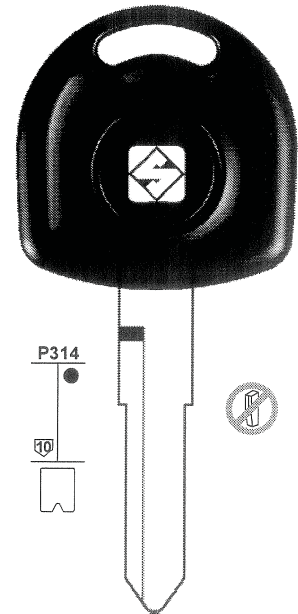

HU87RT18

www.silca.de

Copyright by Silca S.p.A. 2006

Irrtum und Druckfehler vorbehalten.

Silca GmbH
Siemensstr. 33
D-42551 Velbert
Telefon +49 2051 / 271-0
Telefax +49 2051 / 271-172
e-mail: verkauf@silca.de
internet: www.silca.de

Für die vollständigen Informationen bitte auch die GesamtUpdates aus dem Internet unter www.silca.de downloaden.

Bitte beachten Sie, dass nur die oben genannten Artikel ab Lager Silca Deutschland kurzfristig verfügbar sind.



A Member of the Kaba Group

PER:
FOR:

KYMCO

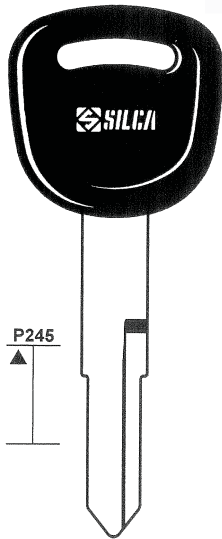

KYM2P KYM2RP

MAZDA

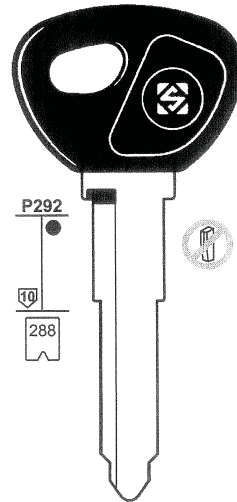

MAZ24RT17
..... 10100-12283
..... 20100-23284



3

PER / FOR

KYMCO (ROK)

MAZDA (J)

MITSUBISHI (J)

MITSUBISHI

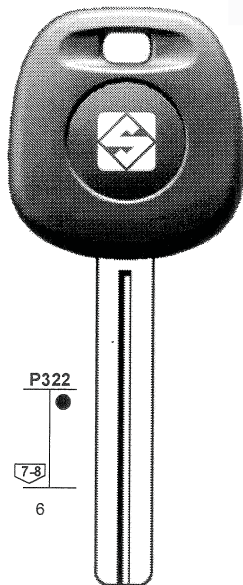

MIT14BT5 MIT14BT14

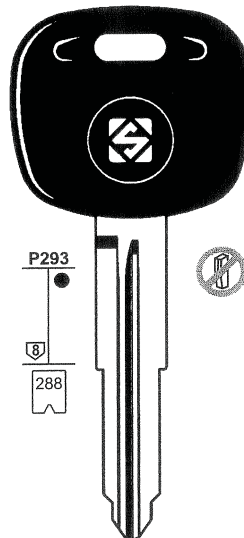



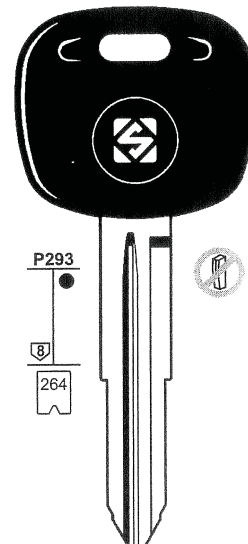





MIT11RT19
..... 30010-32009

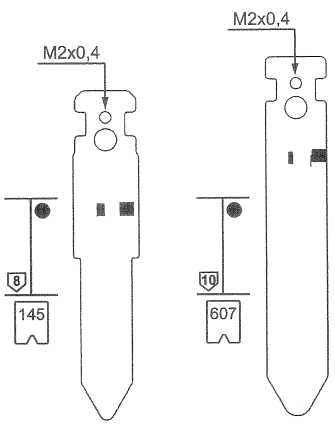

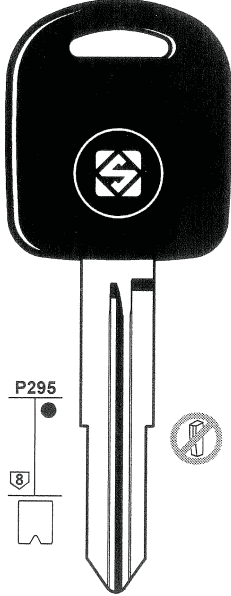
MIT8T19
E..... 5001-7000
E..... 7001-7700

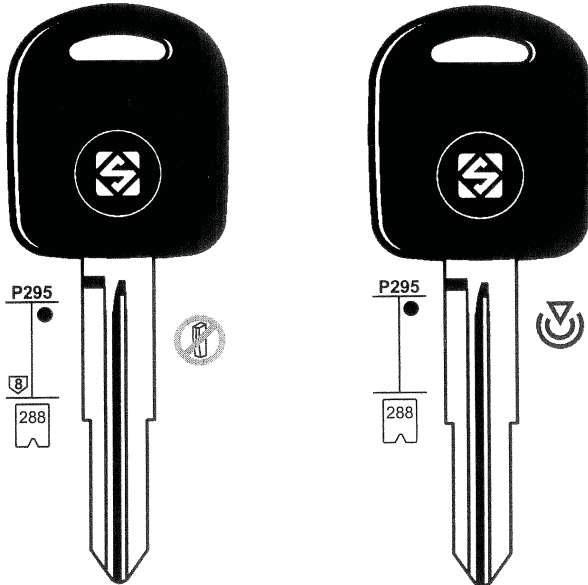
Copyright by Silca S.p.A. 2006

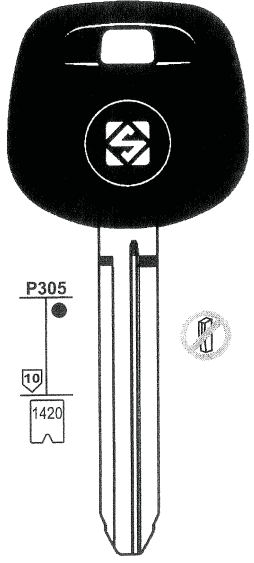
www.silca.de

 <div style="font-size: 2em; font-weight: bold; border: 1px solid black; padding: 5px; width: 40px; margin: 0 auto;">4</div> <table border="1" style="width: 100%; border-collapse: collapse;"> <tr> <td style="text-align: left; padding: 2px;">PER / FOR</td> <td></td> </tr> <tr> <td style="text-align: left; padding: 2px;">NISSAN</td> <td style="text-align: right; padding: 2px;">(J)</td> </tr> <tr> <td style="text-align: left; padding: 2px;">SUZUKI</td> <td style="text-align: right; padding: 2px;">(J)</td> </tr> <tr> <td style="text-align: left; padding: 2px;">TOYOTA</td> <td style="text-align: right; padding: 2px;">(J)</td> </tr> </table>	PER / FOR		NISSAN	(J)	SUZUKI	(J)	TOYOTA	(J)	<p>PER: FOR:</p> <h2 style="margin: 0;">NISSAN</h2>  <div style="display: flex; justify-content: space-around; margin-top: 20px;"> <div style="text-align: center;">  NSN11T X 1-8000 X 8001-9000 </div> <div style="text-align: center;">  NSN14T 1-22185 </div> </div>	<h2 style="margin: 0;">SUZUKI</h2>  <div style="text-align: center; margin-top: 20px;">  SZ11T18 </div>
	PER / FOR									
	NISSAN	(J)								
	SUZUKI	(J)								
TOYOTA	(J)									
<h2 style="margin: 0;">SUZUKI</h2>  <div style="display: flex; justify-content: space-around; margin-top: 20px;"> <div style="text-align: center;">  SZ11RT18 18100-19299 19300-19617 </div> <div style="text-align: center;">  SZ11RT5 10100-12283 18100-19299 </div> </div>	<h2 style="margin: 0;">TOYOTA</h2>  <div style="text-align: center; margin-top: 20px;">  TOY43AT18 10001-15000 50000-59999 60000-69999 </div>									

www.silca.de

Copyright by Silca S.p.A. 2006

PER: **FORD (EU+USA)**
FOR:

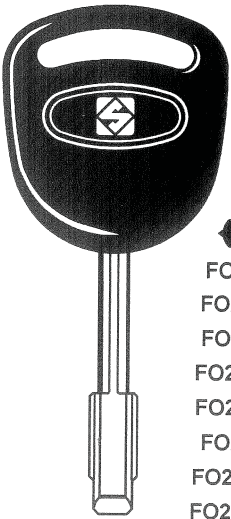

FO21P
FO21PL
FO21T3
FO21T3L
FO21T17
FO21T7
FO21T3M
FO21EH1

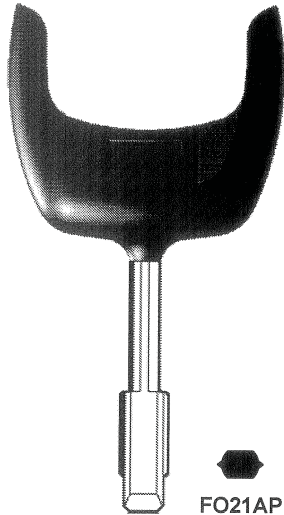

FO21AP

OPTIONAL



IDEA

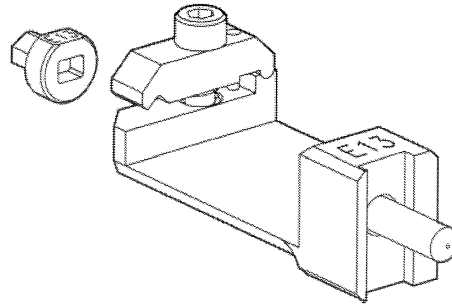

D730302ZB

Adapter für FO21 Tibbe Schlüssel

Ab Idea Software Version 1.5.041 DB7.00



5

PER / FOR

FORD (EU+USA)

KABA (CH)

KYR (I)

PER: **KABA**
FOR:

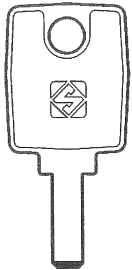

KA8

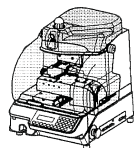

TRIAX-E.CODE

OPTIONAL

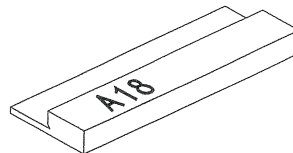

D729845ZB

A18 adapter
Adattatore A18
Adapter A18
Adaptateur A18
Adaptador A18

PER: **KYR**
FOR:

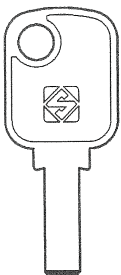

SCU1

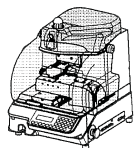

TRIAX-E.CODE

OPTIONAL

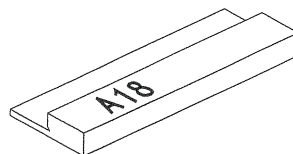

D729845ZB

A18 adapter
Adattatore A18
Adapter A18
Adaptateur A18
Adaptador A18

www.silca.de

Copyright by Silca S.p.A. 2006

Irrtum und Druckfehler vorbehalten.